

HUSKY L

HUSKY M

KAMEI

Gebrauchsanleitung

Komfort-Schiebe-Befestigung
mit Druckschloß

Instructions for use

Comfort sliding fitting
with push button lock

Instructions d'utilisation

Montage glissé facile
avec la serrure de pression

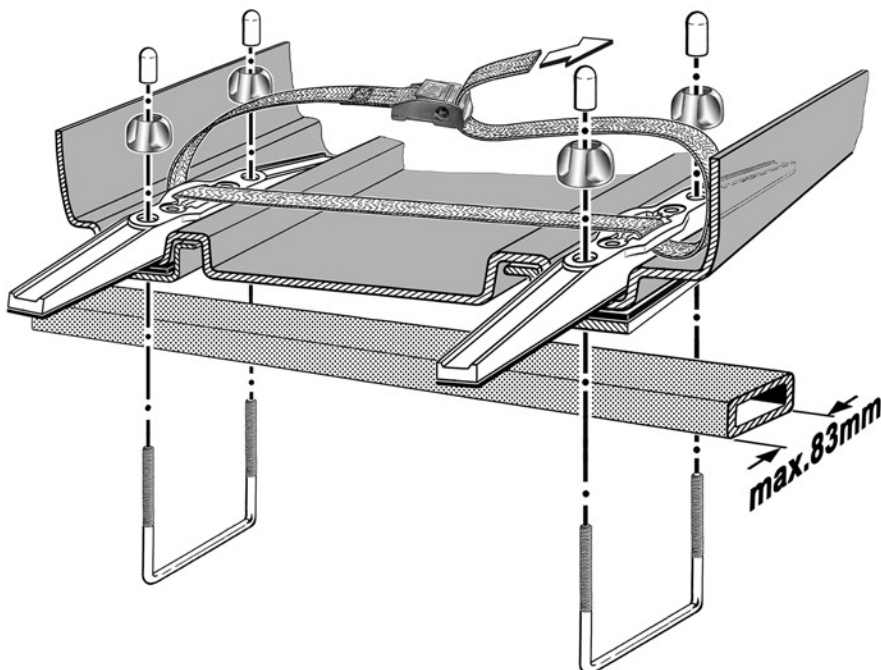
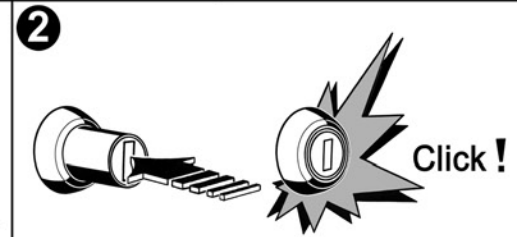
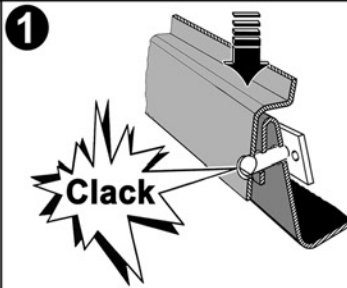
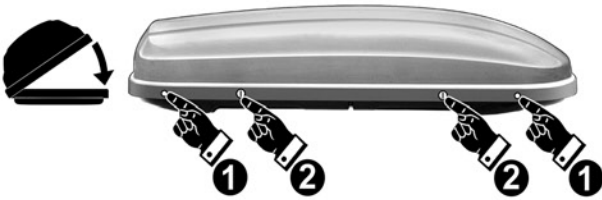
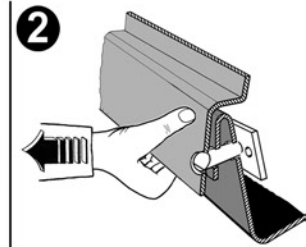
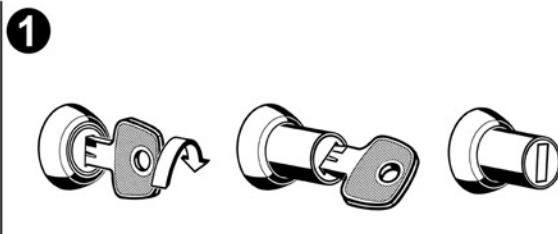
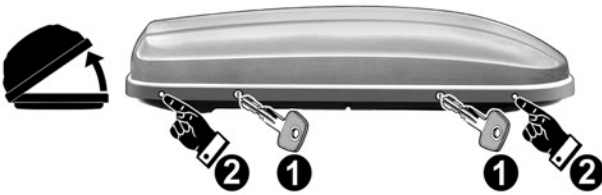
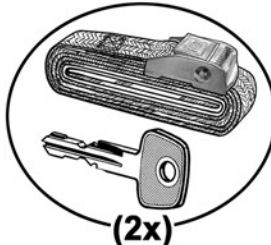
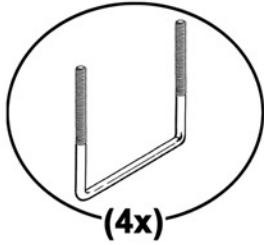

Art.-Nr. 0 52003 10

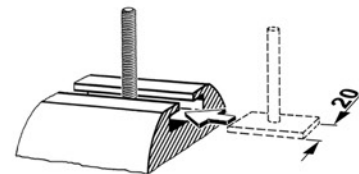

Art.-Nr. 0 52004 10

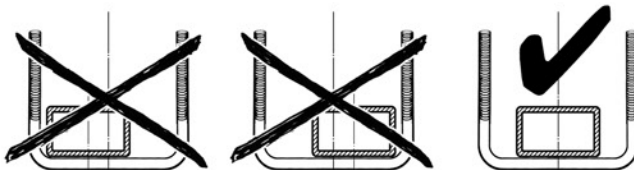
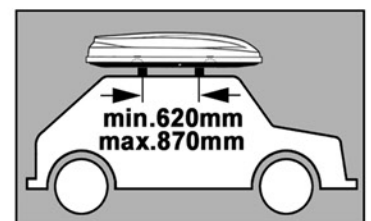
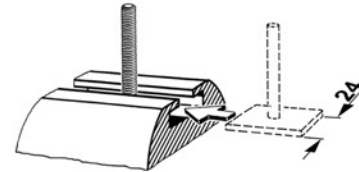

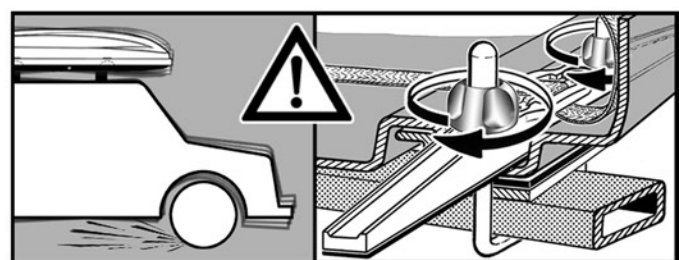
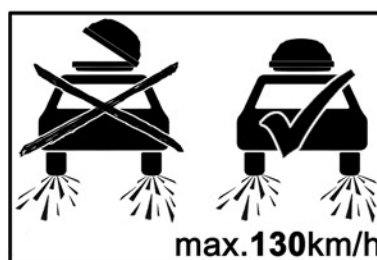
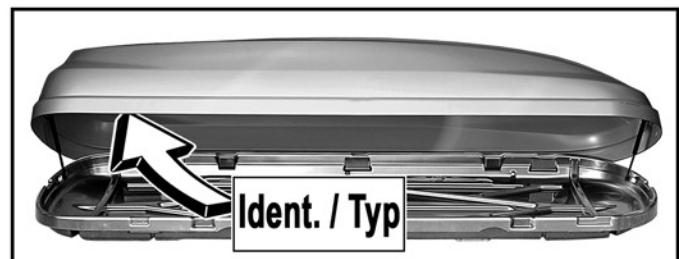
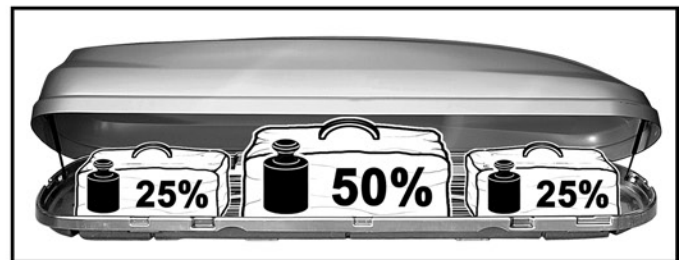
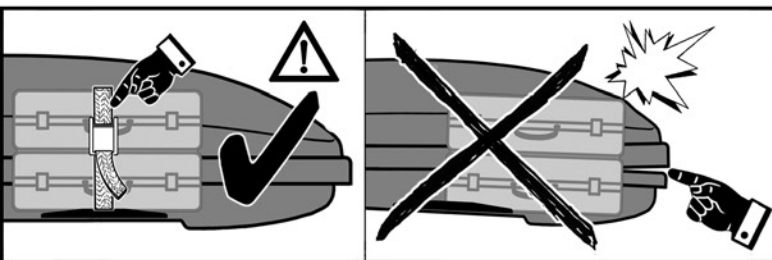
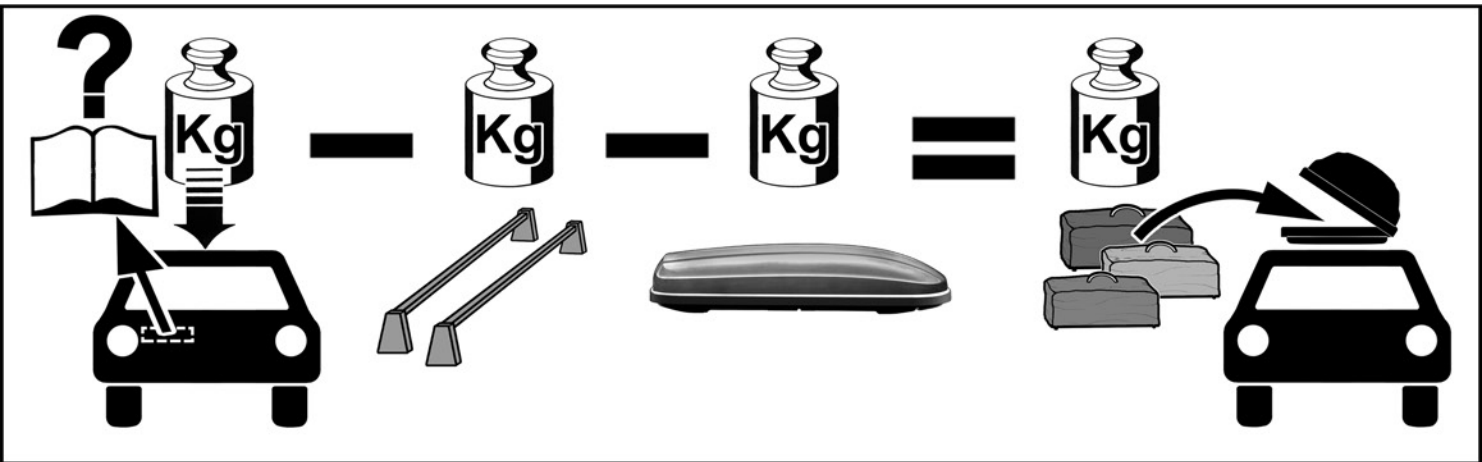
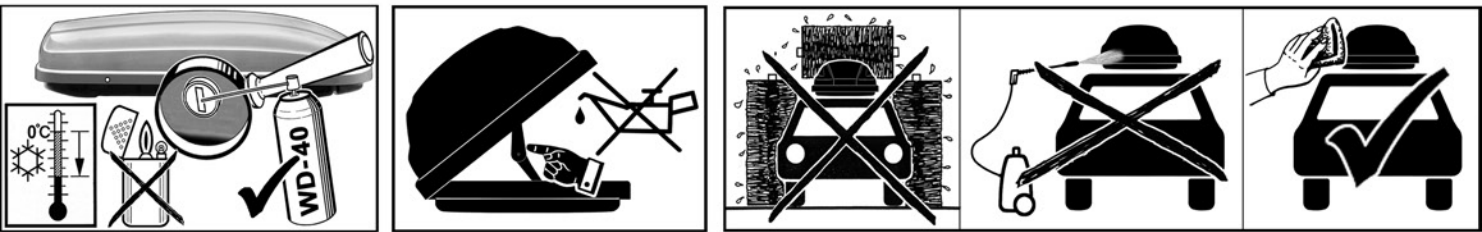
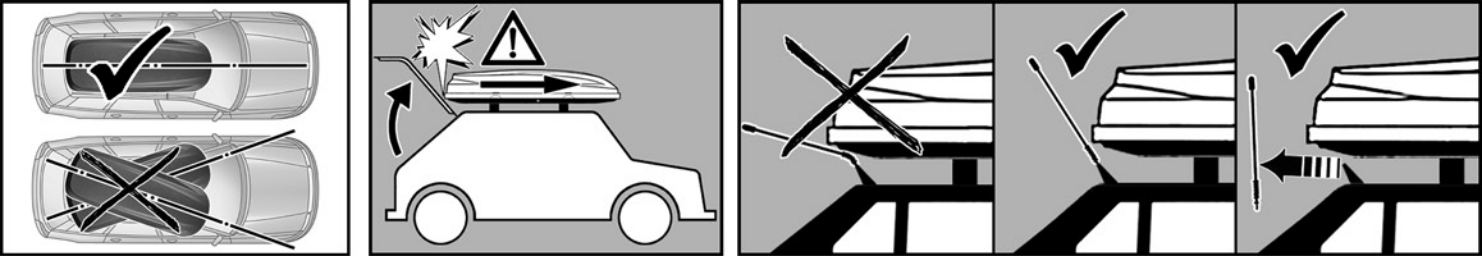

Dachcontainer Typ 81200

Hersteller: KAMEI 01805 - 26 34 46

Haupt-Verkaufsbezeichnung	Maße			Volumen Schüttgut	Eigengewicht	Gewichte	
	Länge cm	Breite cm	Höhe cm			zulässige Tragfähigkeit kg	Maximalgewicht beladen kg
Husky L	190	75	38	330	13	50	63
Kamei 450	220	82	38	450	19	50	69
Husky M	220	62	35	300	14	50	64