

➤ Instructions

Thule FreeRide 532



EN	Roof-mounted bike carrier
DE	Dachfahrradträger
FR	Porte-vélo sur le toit
NL	Fietsdrager voor op het dak
IT	Portabicici da installare sul tetto
ES	Portabicicletas de techo
PT	Suporte para bicicleta para teto
SV	Takmonterad cykelhållare
DK	Tagmonteret cykelholder
NO	Takmonterte lasteholdere
FI	Katolle asennettava polkupyöräteline
ET	Katusese paigaldatav jalgrattahoidik
LV	Uz jumta uzstādāms velosipēdu turētājs
LT	Ant stogo tvirtinami dviračių laikikliai
PL	Bagażnik rowerowy montowany na dachu
RU	Устанавливаемое на крыше крепление для велосипедов
UK	Багажник для велосипедів, що монтується на даху
BG	Покривен багажник за велосипеди
CS	Nosič jízdních kol s montáží na střechu
SK	Nosič bicyklov s montážou na strechu

SL	Nosilec za kolesa
HR/BiH	Krovni nosač bicikla
RO	Suport pentru bicicletă montat pe pavilion
HU	Tetőre szerelhető kerékpártartó
EL	Σχάραρ ποδηλάτου οροφής
TR	Araç üstüne bağlanan bisiklet taşıyıcı
ZH	頂置自行車架
JA	ルーフマウント型サイクルキャリア
KO	지붕 장착 자전거 캐리어
TH	โครงยึดจับจักรยานแบบติดตั้งบนหลังคา

حامل الدراجة للتثبيت على السقف
מנשא אופניים מונח על הגג

HE
AR

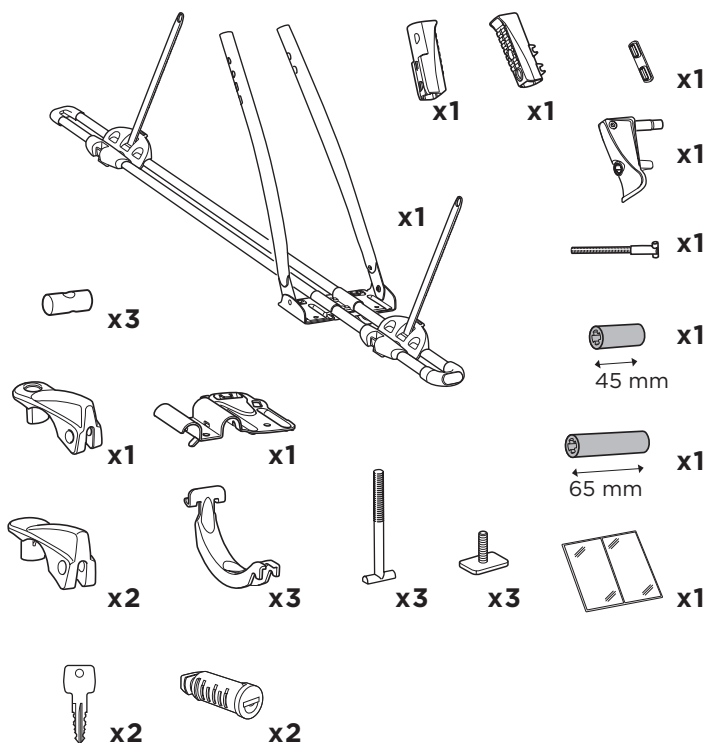
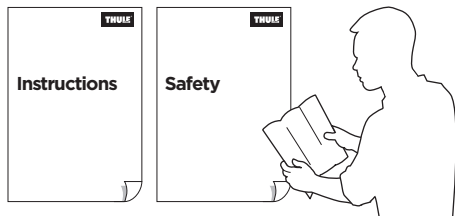

i



Thule WingBar Evo

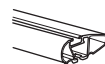

Thule WingBar

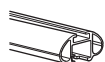

Thule AeroBar

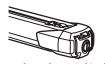

Thule SlideBar

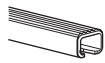

Thule SquareBar

i

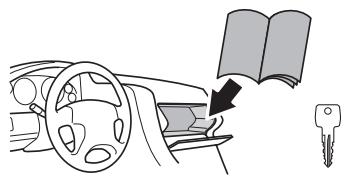
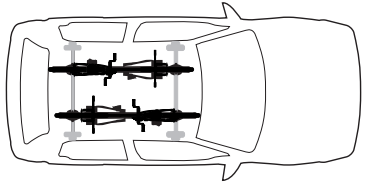
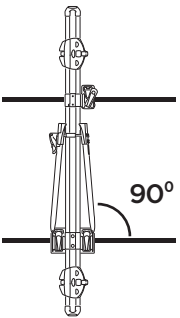
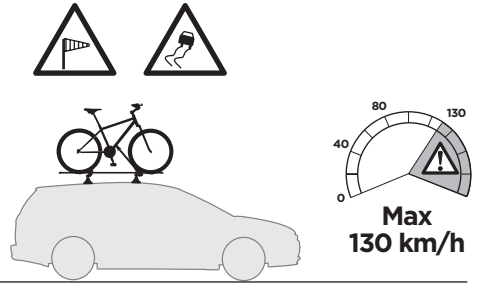
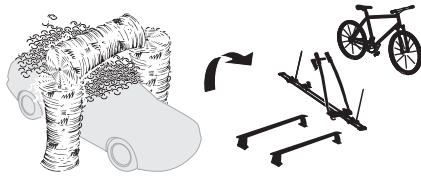
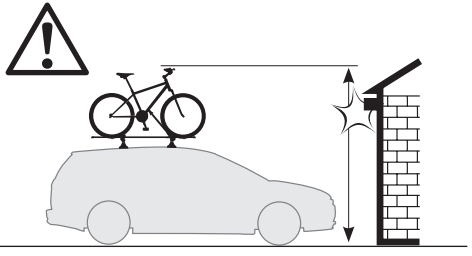
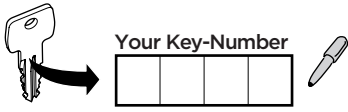

1

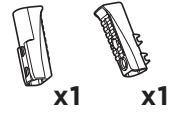
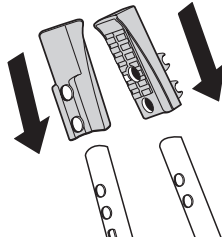

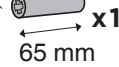
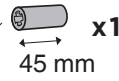

2

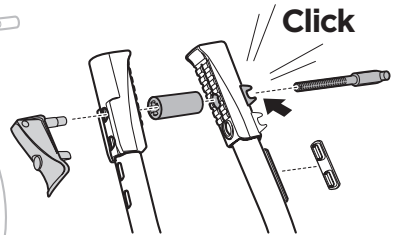
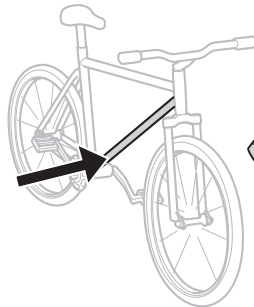

 $\varnothing 22 - 58 \text{ mm}$



 $\varnothing 59 - 70 \text{ mm}$
 80
 65
} **Max 65 x 80 mm**

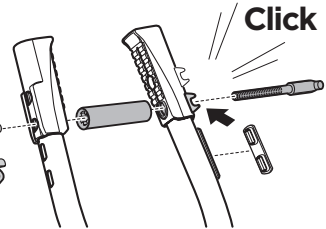
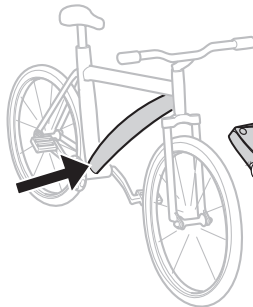

3

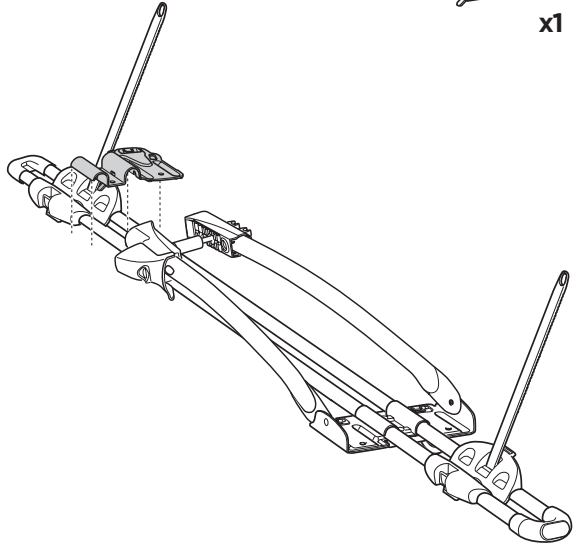
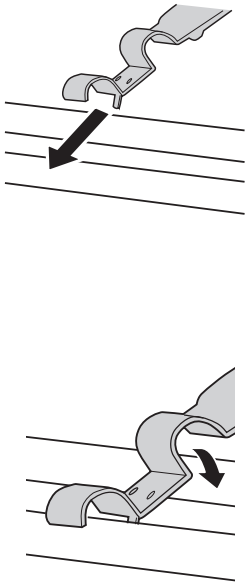

4

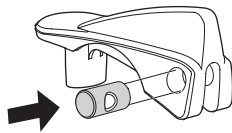
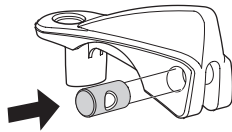

5

i

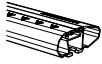

Thule WingBar Evo

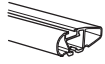

Thule WingBar



x1



x3

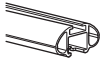

Thule AeroBar



Thule SlideBar



x2

A

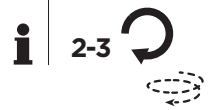
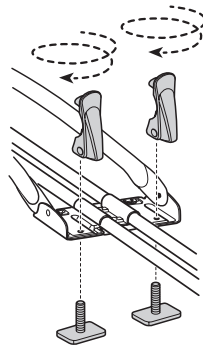
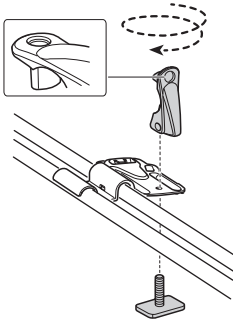

B

i



THULE WingBar Evo

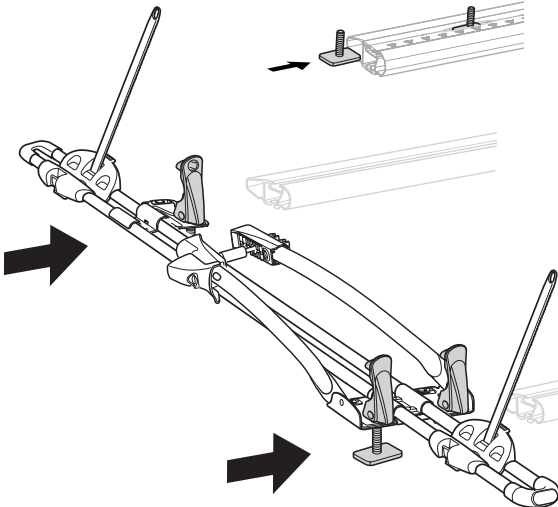
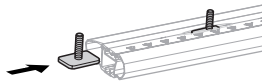

C

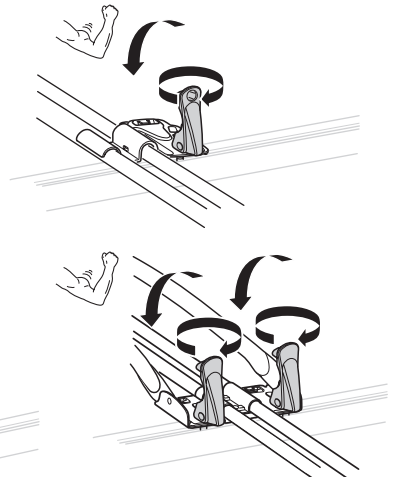

5

i



Thule SquareBar

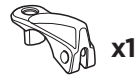

x1



x3



x2



x3

A

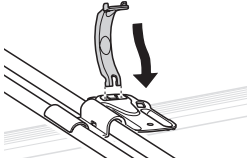

B

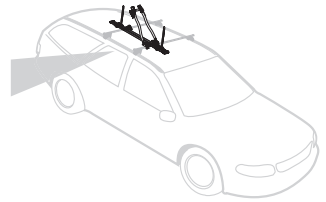
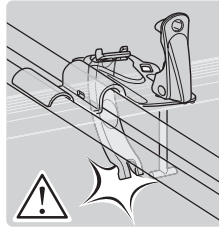
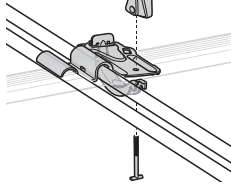

C

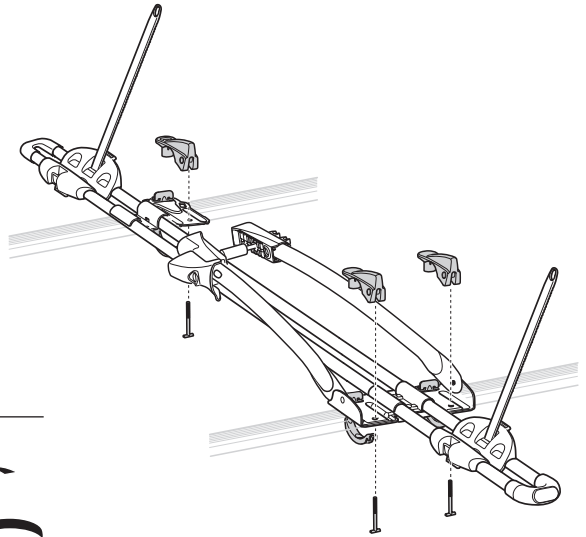
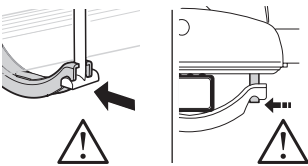

D

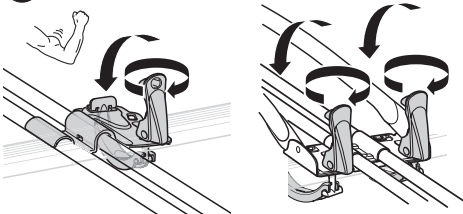

6

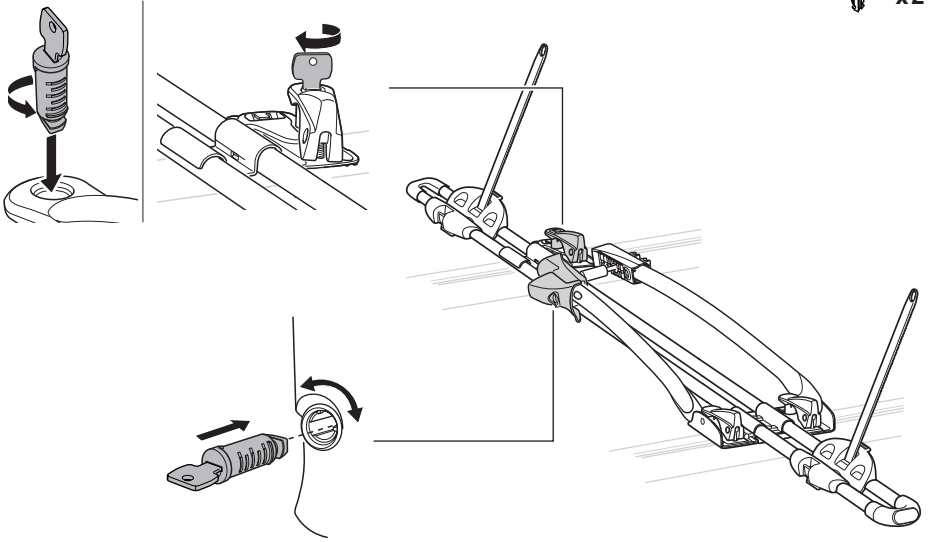

7

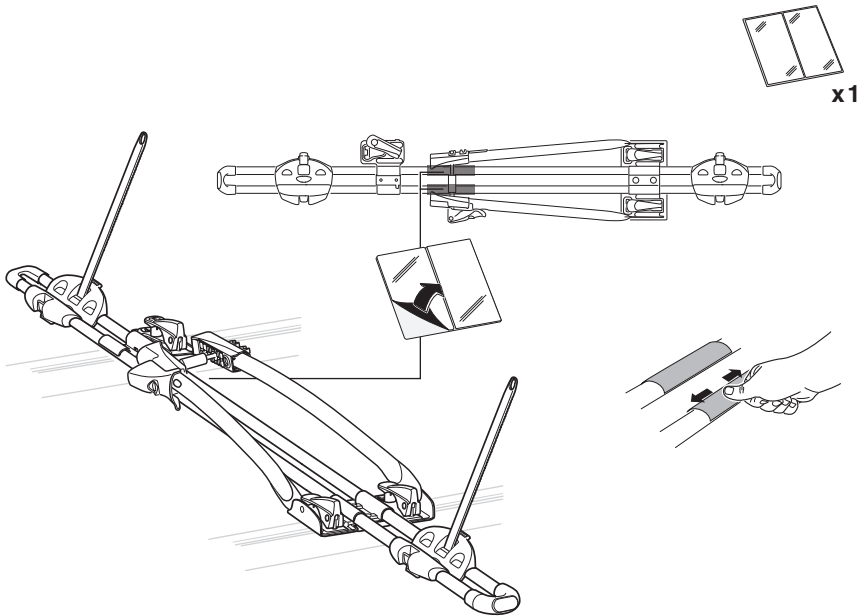

8

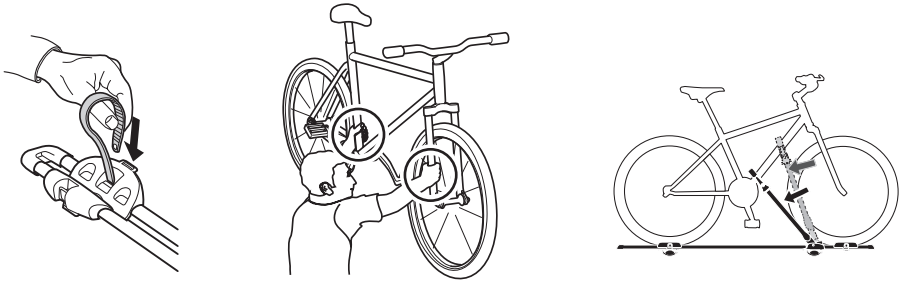

9

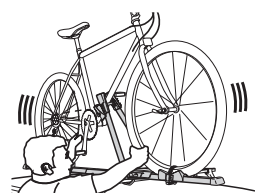
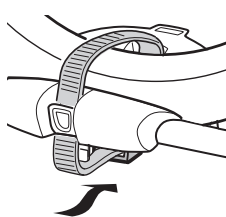
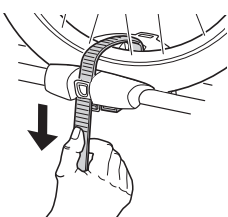
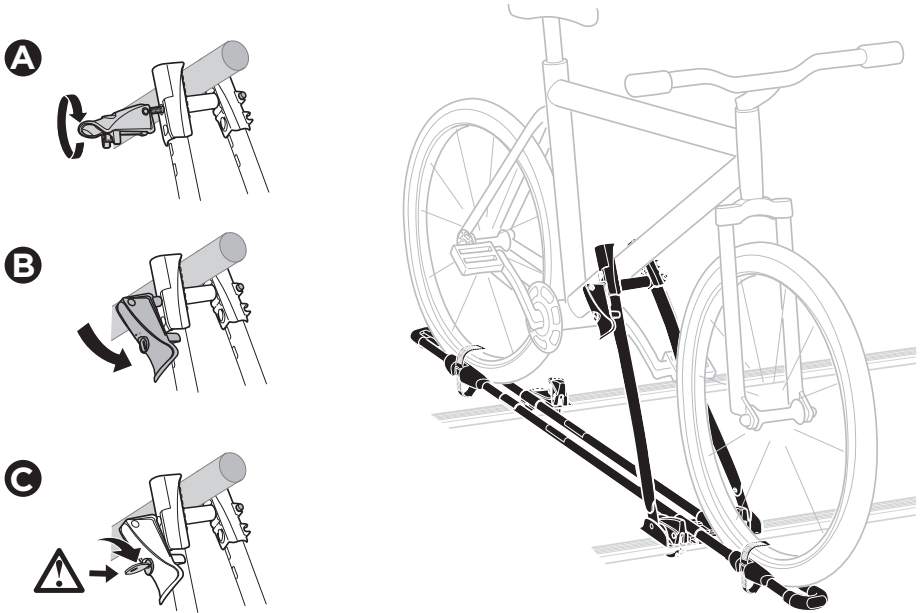

EN	Left-hand fitting	UK	Установка на ліву сторону
DE	Montage links	BG	Монтаж отляво
FR	Montage côté gauche	CS	Montáž z levé strany
NL	Montage aan de linker kant	SK	Montáž na ľavej strane
IT	Montaggio a sinistra	SL	Pritrjevanje z leve strani
ES	Montaje a izquierda	HR/BIH	Montaža s lijeve strane
PT	Montagem do lado esquerdo	RO	Montare pe partea stângă
SV	Vänstermonterad	HU	Bal oldalról szerelhető
DK	Venstremontering	EL	Τοποθέτηση αριστερά
NO	Venstremontering	TR	Sol elle montaj
FI	Asennus vasemmalle		התקנה שמאלית HE
ET	Vasakpoolne kinnitamine		التركيب في الجانب الأيسر AR
LV	Kreisais stiprinājums	ZH	从左侧安装
LT	Kairysis pritvirtinimas	JA	左手装着
PL	Montaż z lewej	KO	왼손 장착
RU	Установка на левую сторону	TH	ตัวยึดด้านซ้ายมือ

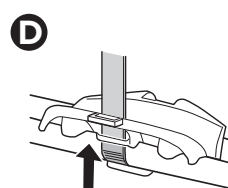
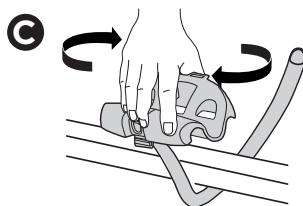
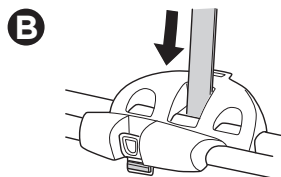
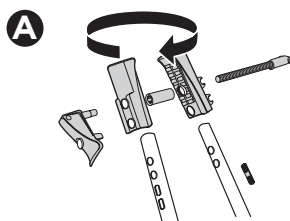
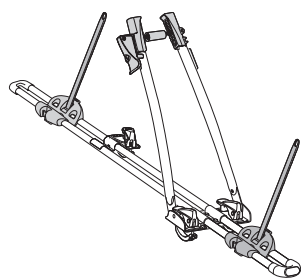

EN Accessories	DK Tilbehør	UK Аксессуары	EL Εξαρτήματα
DE Zubehör	NE Tilbehør	BG Принадлежности	TR Aksesuarlar
FR Accessoires	FI Lisävarusteet	CS Doplòky	الملحقات AR
NL Accessoires	ET Lisavarustus	SK Príslušenstvo	אביזרים HE
IT Accessori	LV Piederumi	SL Dodatki	ZH 附件
ES Accesorios	LT Priedai	HR/BiH Dodaci	JA アクセサリー
PT Acessórios	PL Akcesoria	RO Accesorii	KO 액세서리
SV Tillbehör	RU Аксессуары	HU Tartozékok	TH อุปกรณ์เสริม

Thule One-Key System

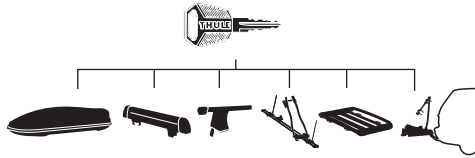

450400  (x4)

450600  (x6)

450800  (x8)

451200  (x12)

451600  (x16)

Thule Adapter 889-3

